

Hubbell SystemOne – Modular In-Floor System
Flexible and responsive to change

HUBBELL



Floor Box



Poke-Through



One Universal Cover



Endless Applications



Nobody delivers like Hubbell Commercial Solutions



Hubbell SystemOne – Modular In-Floor System

Hubbell SystemOne is an innovative system that provides consumers with the flexibility to create personal solutions for the most demanding multi-service applications for both flush in-floor boxes and Fire rated poke-throughs.

Hubbell SystemOne features a unique universal cover assembly and a wide variety of application sub-plates that install on both Hubbell flush floor boxes and fire rated poke-throughs. Now, whatever the application, Hubbell SystemOne delivers a consistent, aesthetic and functional solution for applications “in-the-floor” or “through-the-floor” for power, voice, data, and audio/video requirements.

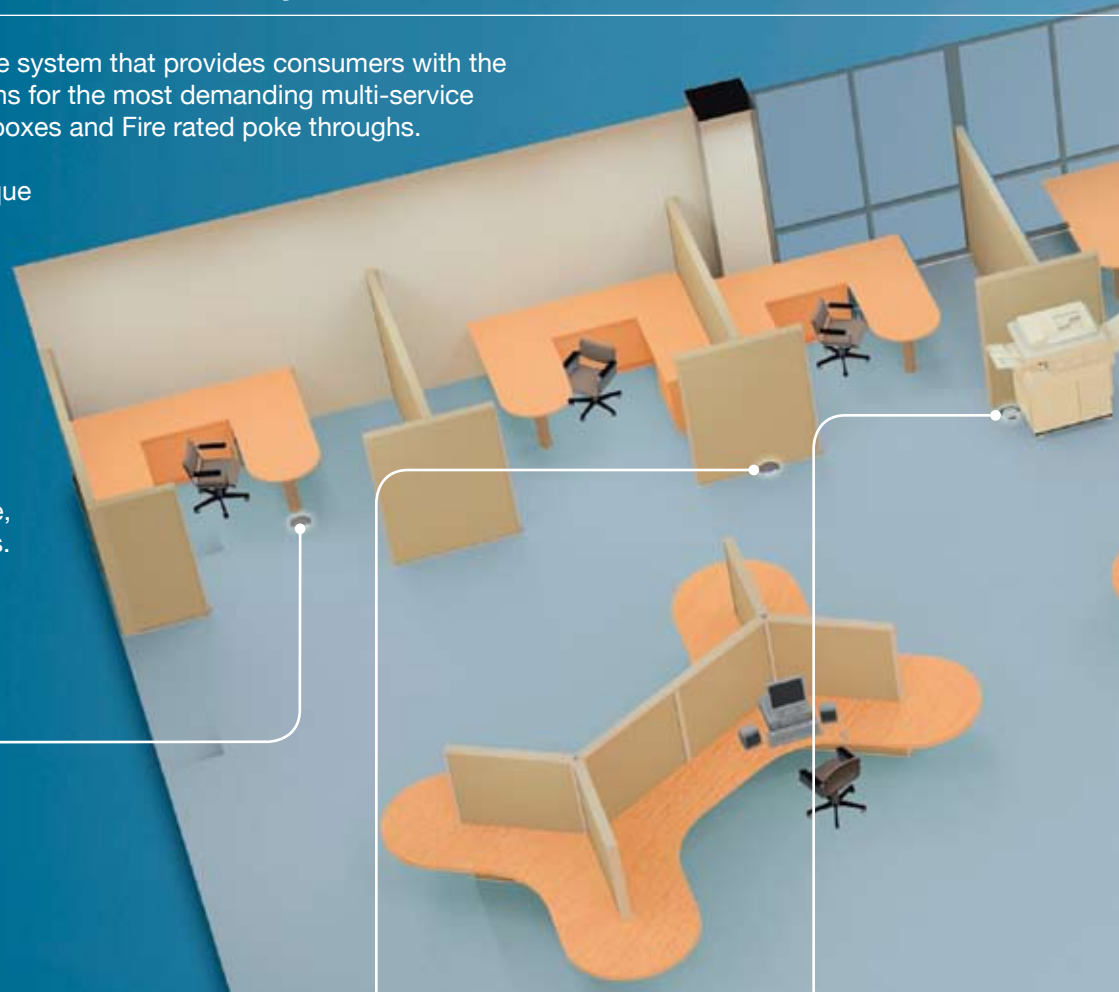

4X4 Applications

Provides maximum power capacity for flush, multi-service applications. This sub-plate features a pre-wired four outlet 20A, 125V receptacle and four openings for snap-in flush mount Hubbell modular jacks and audio/video snap-in connectors



Furniture Feed Application

Excellent solution for feeding both power and communication services to modular furniture systems in an open office environment. This unique multi-service furniture feed features a 3/4" N.P.T. power hub and an oversized 1 1/2" N.P.T. data hub for increased cable capacity.



Twist-Lock® Applications

This unique subplate provides the ability to provide a locking power source and data connections in the same poke-through or floor box assembly. Memory sensitive equipment such as a copier or printer connected to the LAN is a typical multi-service application.



Advantage HUBBELL

- **Best in Class Products**
Universal Cover installs on both Floor Boxes and Poke-Throughs.
- **Ease of Installation**
Modular sub-plate design facilitates quick and efficient moves, adds and changes.
- **Application Solutions**
Using two 6-port low voltage outlet frames in the rectangular Style Line® sub-plate creates a 12-port flush all communications poke-through or floor box.



Style Line® Application

This sub-plate incorporates two standard rectangular Style Line® openings to be used for a variety of power and/or data applications. This sub-plate accommodates 15 or 20A standard or isolated ground, GFCI, and surge receptacles. Using low voltage outlet frames can provide up to 6-ports multi-service and 12-ports all communication. (The highest poke-through and flush floor box all communication capacity on the market).



Multimedia Applications

The Hubbell InfineStation™ module sub-plate is designed to meet the needs of today's converged multimedia networks. This sub-plate allows for three recessed units of InfineStation modules and a single 20A/125V power receptacle. This is the perfect solution for board/training rooms where data/voice/audio/video connections are needed in one work area.



Extron® Electronics Applications

Three sub-plates are specifically designed to support Extron® Electronics MAAP Series (Mini Architectural Adapter Plates) and AAP Series (Architectural Adapter Plates) for a customized A/V solution. Extron adapter plates provide pass-through connectivity for audio, video, phone, data, power, and control connectors.

Two Delivery Systems

1. Round Non-Metallic Concrete Floor Box

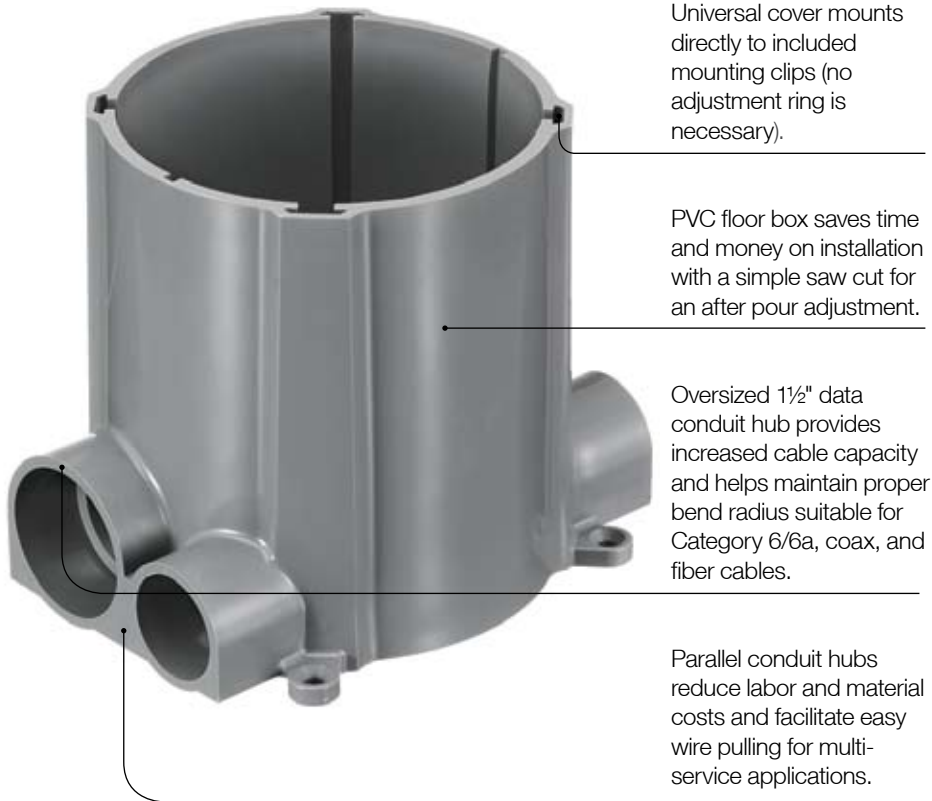

- Accepts Hubbell SystemOne universal cover for both carpet and tile applications.
- High-strength, corrosion resistant PVC construction is suitable for on or above grade applications.
- For use in concrete pours from 3" to 5" depending on application sub-plate. (see sub-plate ordering information on page 7).
- Features four parallel entry hubs.
 - two 1" and two 1½"
- Supplied with concrete cap, conduit reducers, and conduit hub plugs.
 - two 1½" to 1" Low voltage conduit reducers
 - two 1½" to ¾" Low voltage conduit reducers
 - two 1½" and two 1" conduit plugs
- PVC floor box and universal cover combination exceed UL514A scrub water exclusion requirements.
- 100 cubic inches (prior to cutting) or 19½ cubic inches per inch of box depth.

2. Fire Rated Poke-Through



- Accepts Hubbell SystemOne universal cover for both carpet and tile applications.
- Excellent solution for both retrofit and new construction.
- Brings power, voice, data and multimedia precisely where needed.
- Suitable for use in air handling spaces in accordance with sec 300-22(C) of the NEC.
- Installs in 4" (101.6mm) diameter core drilled hole through concrete.
- UL Listed for use in 1-4 hour rated floors.
- Poke-through fitting and universal cover combination exceed UL514A scrub water exclusion requirements.

One Universal Cover Assembly

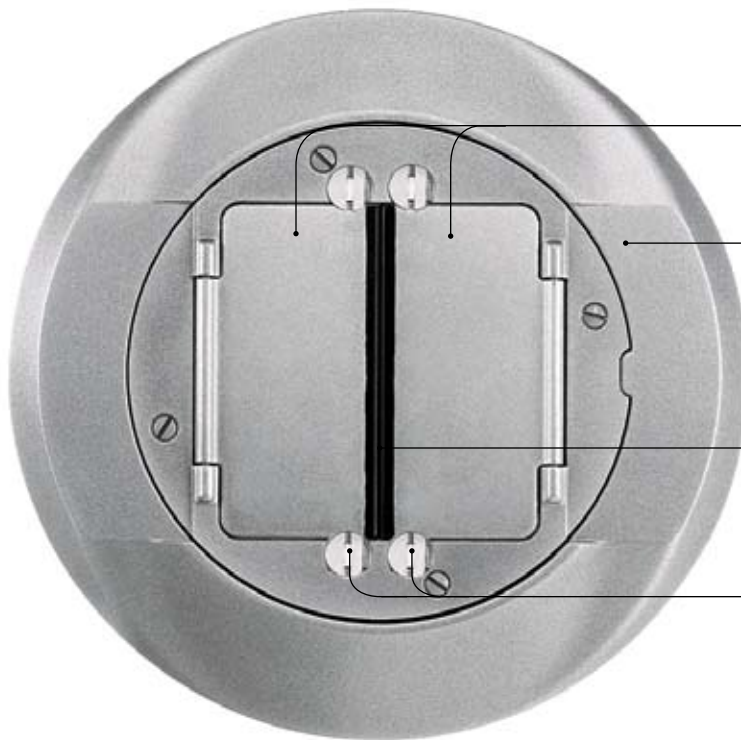

Oversized hinged doors rotate 180 degrees flush with carpet flange or tile.

Carpet flange features raised hinged door supports.

Over-molded access doors prevent dirt, and debris from entering power and communication compartments.

Security screws allow each door to be opened and secured independently.

- The universal cover assembly installs onto both the SystemOne PVC round floor box and fire-rated poke-throughs.
- Consists of a carpet or tile flange and universal cover assembly.
- All components feature durable cast aluminum construction with powder coat finishes in brass, aluminum, black, gray, and ivory colors.
- Features ScrubShield™ technology to exceed UL514A and UL514C for scrub water exclusion tests.

Endless Applications



Hubbell SystemOne was designed to give specifiers and contractors the flexibility to create their own application specific combinations.

This modular solution utilizes application sub-plates that install into ONE universal cover for Hubbell SystemOne Floor Boxes and Poke-Throughs.

While no one can predict the future, Hubbell's modular sub-plate design allows users to economically upgrade Hubbell SystemOne Poke-Throughs and Floor Boxes to accommodate future moves, adds and changes.

- Hubbell 4X4 – four 20A, 125V receptacles and four openings for voice/data jacks and multimedia connectors.
- Hubbell InfineStation™ front loading modular connectivity provides for simple field configuration for Hubbell Xcelerator™ Jacks, and A/V or fiber snap-in connector modules.
- Extron® MAAP Series (mini architectural adapter plates) and AAP Series (architectural adapter plates) for a customized A/V solution.
- Open system solutions for proprietary connectivity including Ortronics®, Siemon™, Panduit®, SYSTIMAX®, and keystone based jacks.
- Furniture feed for both power and communication services to modular furniture systems.
- Twist-Lock® receptacle with LAN connectivity.
- GFCI, surge, and Style Line® receptacles.

Hubbell SystemOne – Concrete Floor Box



Catalog Number

Round Multi-Service PVC Floor Box **S1PFB**

Available for both single and dual service. Supplied with reusable concrete cap, conduit hub plugs and reducers. Features two 1½" hubs for low voltage and two 1" hubs for power. Reducers provide reduction from 1½" to 1" or 1½" to ¾" PVC conduit. Markings inside the box indicate cubic inch capacity. Universal cover and sub-plate must be ordered separately.

Catalog Number

Side by Side Divider **S1DIV1**

Used to isolate power and communication compartments for catalog number S1SP (Style Line®/GFCI) sub-plate when used in multi-service applications. Inch markings are clearly marked on the divider and correspond directly to the inch markings on the exterior of the PVC box. All other sub-plates include the appropriate dividers.



Hubbell SystemOne – Poke-Through (One Piece and Assembled Units)



Dual Channel Floor Fitting **S1PTFIT**

Through floor fitting with two 1" E.M.T. trade size conduit stems to feed power and communication services. For use with Hubbell SystemOne universal covers and all Hubbell sub-plates except 4X4 series. Universal cover and sub-plate must be ordered separately.

4X4 Floor Fittings **S1PT4X4FIT**

Through floor fitting with two ¾" E.M.T. for communications and one ¾" E.M.T. for power. For use with Hubbell SystemOne Universal Covers and the 4X4 and Twist-Lock Series sub-plates only. Universal cover and sub-plate must be ordered separately.

One-Piece 4X4 Poke-Through

Assembled-unit includes Hubbell SystemOne 4X4 Floor Fitting with four pre-wired 20A, 125V receptacles and four keystone openings to accept Hubbell modular jacks and flush multimedia snap-in connectors. Receptacles feature single or two circuit wiring as well as isolated ground capability. Finish flange and universal cover are available in:

Aluminum Finish	S1PT4X4AL
Brass Finish	S1PT4X4BRS
Black Finish	S1PT4X4BL
Gray Finish	S1PT4X4GY

One-Piece Dual Style Line Poke-Through

Assembled-unit includes a Hubbell SystemOne dual channel floor fitting (S1PTFIT) and two Style Line openings to accept two Style Line, surge or GFCI receptacles. Additionally, outlet frames can be used to convert the application to a 6-port multi-service or a 12-port all communication solution. Finish flange and universal cover are available in:

Aluminum Finish	S1PTAL
Brass Finish	S1PTBRS
Black Finish	S1PTBL
Gray Finish	S1PTGY

One-Piece Modular A/V Poke-Through

Assembled-unit includes a Hubbell SystemOne dual channel floor fitting (S1PTFIT) and a Hubbell SystemOne InFINEStation™ sub-plate to provide a 20A power outlet and a recessed single-gang 3 Unit INFINEStation™ opening. This comprehensive data/voice/audio/ and video solution can accommodate 15-Pin VGA, RCA, S-Video, 3.5mm Stereo, and XLR microphone jacks. Finish flange and universal cover are available in:

Aluminum Finish	S1PT3IMAL
Brass Finish	S1PT3IMBRS
Black Finish	S1PT3IMBL
Gray Finish	S1PT3IMGY



Hubbell SystemOne – Universal Covers



Universal cover assembly installs on the new Hubbell SystemOne PVC round floor box and fire rated poke-through floor fittings and accommodates all Hubbell SystemOne sub-plates for carpet and tile applications.

Carpet Assembly

Aluminum Finish	S1CFCAL
Brass Finish	S1CFCBRS
Black Finish	S1CFCBL
Gray Finish	S1CFCGY
Ivory Finish	S1CFCI

Tile Assembly





Aluminum Finish	S1TFCAL
Brass Finish	S1TFCBRS
Black Finish	S1TFCBL
Gray Finish	S1TFCGY
Ivory Finish	S1TFCI

Catalog Number



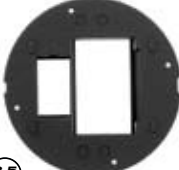

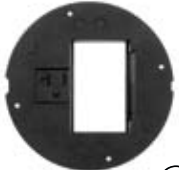

Aluminum Finish	S1TFCAL
Brass Finish	S1TFCBRS
Black Finish	S1TFCBL
Gray Finish	S1TFCGY
Ivory Finish	S1TFCI



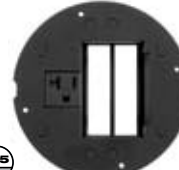
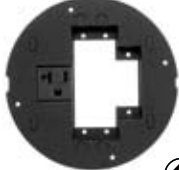

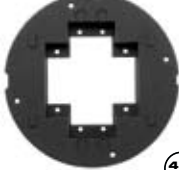

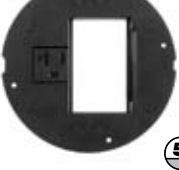































Hubbell SystemOne – Sub-plates

	Catalog Number	Catalog Number	
	Hubbell 4X4 S1SP4X4	All Modular Datacom S1SP4IM	
	Features four pre-wired 20A, 125V receptacles and four openings for Hubbell Xcelerator™ Jacks and snap-in flush audio/video connectors.		Features a recessed single-gang 3 unit and a flush 1 unit InFineStation™ opening. Accepts up to eight UTP, fiber, and audio/video connectors.
	Style Line/GFCI S1SP	Twist-Lock + Data S1SPTL	
	Features two rectangular Style Line® openings. Additionally, two data outlet frames can be used to provide 12-ports of flush connectivity.		Features one standard opening for a Hubbell 20/30A Twist-Lock® device and two openings for Hubbell Xcelerator Jacks or snap-in flush audio/video connectors.
	Hubbell INFINEStation S1SP3IM	Furniture Feed	
	Features one pre-wired 20A, 125V receptacle and a recessed single-gang 3-unit InFineStation opening. This comprehensive power/data/voice/audio/and video solution can accommodate 15-Pin VGA, RCA, S-Video, 3.5mm Stereo, and XLR microphone jacks.		Features one 1½" N.P.T. plug opening for low voltage and one ¾" screw plug opening for power. Includes carpet flange – no universal cover required.
		Black Finish Aluminum Finish Brass Finish Gray Finish	S1SPFBL S1SPFFAL S1SPFFBRS S1SPFFGY
 Signifies minimum depth of concrete pour in inches for Hubbell SystemOne S1PFB floor box.			

Open Systems Sub-plates

	Catalog Number	Catalog Number	
	Extron MAAP S1SPEXT1	Ortronics TracJack® S1SPTRAC	
	Features one pre-wired 20A, 125V receptacle and a recessed opening for 3 single Extron® MAAP Series Adapter Plates.		Features one pre-wired 20A, 125V receptacle and a recessed bezel for six Ortronics TracJack® Modules.
	Extron AAP S1SPEXT2	Siemon MAX® Series S1SPMAX	
	Features one pre-wired 20A, 125V receptacle and a recessed opening for 1 single Extron MAAP Series Adapter Plate and 2 single AAP Series Adapter Plates.		Features one pre-wired 20A, 125V receptacle and a recessed bezel for six Siemon MAX® Modules.
	Extron Datacom S1SPEXT3	Panduit Mini-Com® 4X4 S1SP4X4PA	
	Features recessed openings for 2 single Extron MAAP Series Adapter Plates and 2 single AAP Series Adapter Plates.		Features four pre-wired 20A, 125V receptacles and four openings for Panduit Mini-Com® Connectivity.
	Ortronics Series II® S1SPORT	SYSTIMAX 4X4 S1SP4X4SYS	
	Features one pre-wired 20A, 125V receptacle and a recessed single-gang opening for three 1 unit size Ortronics Series II® Modules.		Features four pre-wired 20A, 125V receptacles and four openings for CommScope SYSTIMAX® Connectivity.
 Signifies minimum depth of concrete pour in inches for Hubbell SystemOne S1PFB floor box.			

Power, Data, Audio and Video Accessories

Modular Jacks	Multimedia Connectors	InfineStation™ Modules (Office White)	Outlet Frames	Wiring Devices
HBL6OW* Category 6 Universal Wired Office White 	SIFOW** F-Type F/F Coupler Office White 	DFBM05OW Blank .5 Unit 	FCX244OW++ 2-Port Style Line Frame Office White 	HBL2152 +++ 15A 125V Style Line Duplex Receptacle Brown 
HBL5EOW* Category 5e Universal Wired Office White 	SIFGOW** Gold F-Type F/F Coupler Office White 	DFBM10W Blank 1 Unit 	FCX344OW++ 3-Port Style Line Frame Office White 	HBL2162 +++ 20A 125V Style Line Duplex Receptacle Brown 
HBLUOW* USOC 6-Position Office White 	SIRCABK*** RCA 110 Punch Down Black 	DFBM15OW Blank 1.5 Unit 		
SIBOWPK10** Blank Module Office White 	SIRCAFFOW + Gold RCA F/F Coupler Pass-Thru Office White 	DF1KOW 1-Port Keystone Flat 1 Unit 	FCX444OW++ 4-Port Style Line Frame Office White 	HBL2310 20A 125V Twist-Lock Receptacle L5-20R (1.56" boss diameter) Black 
<p>* Office White is standard color. For other colors, replace 'OW' as follows: BK = Black B = Blue EI = Electric Ivory GY = Gray GN = Green OR = Orange R = Red TI = Telco Ivory W = White Y = Yellow.</p> <p>** Office White is standard color. For other colors, replace 'OW' as follows: GY = Gray I = Telco Ivory W = White.</p> <p>***Standard housing color is Black. For other colors, replace 'BK' as follows: OW = Office White W = White Y = Yellow</p> <p>+ Standard housing color is Office White. For other colors, replace 'OW' as follows: R = Red W = White Y = Yellow BK = Black</p> <p>++ Office White is standard color. For other colors, replace 'OW' as follows: GY = Gray I = Telco Ivory W = White BK = Black</p> <p>+++ Standard color is Brown. For other colors, add one of the following to the end of the catalog number: I = Ivory GY = Gray WA = White BK = Black OW = Office White</p>	SIRCASOW + RCA Solder Coupler Office White 	DF2KOW 2-Port Keystone Flat 1 Unit 		
SISVFFBK S-Video F/F Coupler Black 	DFA1KOW 1-Port Keystone Angled 1 Unit 	DFA2KOW 2-Port Keystone Angled 1 Unit 		
SISVOW S-Video 110 Coupler Black 	SIBNCOW** BNC Coupler Office White 		DFA1SCOW 1 SC Duplex Angled 1.5 Unit 	DJOOW++ 2-Port 106 Duplex Frame Office White 
SIFSCOW SC Simplex Adapter Office White 	SISTOW** ST-Style Adapter Office White 	DFA2SCOW 2 SC Duplex Angled 1.5 Unit 	DJ106OW++ 4-Port 106 Duplex Frame Office White 	
		DFRA1KOW 1-Port Keystone Recessed 1.5 Unit 		
		DFRA2KOW 2-Port Keystone Recessed 1.5 Unit 		
		DF115FFOW 15-Pin SVGA F/F, 1 Unit 		
		DF19FFOW 9-Pin F/F 1 Unit 		
		DF115SOW 15-Pin SVGA Screw Terminal 1 Unit 		

Extron is a registered trademark of Extron Electronics.
 MAX and CT Series are registered trademarks of The Siemon Company.
 Mini-Com and Panduit are registered trademarks of Panduit Corp.
 SYSTIMAX is a registered trademark of CommScope, Inc.
 TracJack, Series II and Ortronics are registered trademarks of Ortronics/Legrand.